

# tineco

**PURE ONE** AIR PET SERIES  
Smart Vacuum Cleaner





# CONTENTS

Important Safety Instructions.....	4
Specifications.....	7
Overview.....	8
Accessories.....	10
Assembly.....	12
Operation.....	14
Maintenance.....	18
Troubleshooting.....	20
Warranty.....	21

# Important Safety Instructions

## SAVE THESE INSTRUCTIONS

### Household use only.

When using an electrical appliance, basic precautions should always be followed, including the following:

READ ALL INSTRUCTIONS BEFORE USING (THIS APPLIANCE). Failure to follow the warnings and instructions may result in electric shock, fire and/or serious injury.

### **WARNING** – To reduce the risk of fire, electric shock, or injury:

1. This appliance can be used by children aged from 8 years and above and persons with reduced physical, sensory or mental capabilities or lack of experience and knowledge if they have been given supervision or instruction concerning use of the appliance in a safe way and understand the hazards involved. Children should not play with the appliance. Cleaning and user maintenance shall not be performed by children without supervision.
2. The appliance is not to be used by persons (including children) with reduced physical, sensory or mental capabilities, or lack of experience and knowledge, unless they have been given supervision or instruction.
3. For **INDOOR** use **ONLY**. Do not use the appliance outdoors, nor in commercial or industrial environments. Do not use the appliance on wet surfaces or surfaces with standing water.
4. Do not allow to be used as a toy. Close attention is necessary when used by or near children, pets or plants.
5. Use only as described in this manual. Use only manufacturer's recommended attachments.
6. Do not use with a damaged cord or plug. If appliance has been dropped, damaged, left outdoors, dropped into water, or is not working as it should, return it to a service center.
7. Do not handle charger, including charger plug, and charger terminals with wet hands.
8. Do not block openings. Stop use if openings become blocked. Clean and remove any blocked objects according to the manual instructions.
9. Keep hair, loose clothing, fingers, and all parts of your body away from openings and moving parts.
10. Use extra care when cleaning on stairs.
11. Do not use to pick up flammable or combustible liquids, such as gasoline, or use in areas where they may be present.
12. Do not pick up anything that is burning or smoking, such as cigarettes, matches, or hot ashes.
13. Do not use without a filter.
14. Prevent unintentional activation. Ensure the switch is in the off position before connecting to the battery pack, picking up or carrying the appliance. Carrying the appliance with your finger on the switch or powering on the appliance with the switch on may cause accidents.

15. Disconnect the battery pack from the appliance before making any adjustments, changing accessories, storing the appliance. Such preventive safety measures reduce the risk of starting the appliance accidentally.
16. For the purposes of recharging the battery, only use the detachable supply unit provided with this appliance. A charger that is suitable for one type of battery pack may create a risk of fire when used with another battery pack.
17. Use appliances only with specifically designated Tineco battery packs. Use of any other battery packs may create a risk of injury and fire.
18. When battery pack is not in use, keep it away from other metal objects, like paper clips, coins, keys, nails, screws or other small metal objects, that can make a connection from one terminal to another. Shorting the battery terminals together may cause burns or a fire.
19. Under improper usage, liquid may be ejected from the battery; avoid contact. If contact accidentally occurs, flush with water. If liquid comes into eye contact, seek medical help. Liquid ejected from the battery may cause irritation or burns.
20. Do not use a battery pack or appliance that is damaged or modified. Damaged or modified batteries may exhibit unpredictable behavior resulting in fire, explosion or risk of injury.
21. Do not expose a battery pack or appliance to fire or excessive heat. Exposure to fire or temperatures above 266°F (130°C) may cause an explosion.
22. Follow all charging instructions and do not charge the battery pack or appliance outside of the temperature range specified in the instructions. Charging improperly or at temperatures outside of the specified range may damage the battery and increase the risk of fire.
23. Have servicing performed by a qualified repair person using only identical replacement parts. This will ensure that the safety of the product is maintained.
24. This appliance contains battery cells that are non-replaceable. Do not modify or attempt to repair the appliance or the battery pack except as indicated in the instructions for use and care.
25. Always turn off this appliance before connecting or disconnecting the motorized nozzle.
26. Do not charge or store the appliance outdoors or inside a car. Only charge, store or use the battery in a dry indoor area where the temperature is higher than 39.2°F (4°C) but lower than 104°F (40°C). The charger is for indoor use only.
27. The appliance is only to be used with the unit provided. The plug must be removed from the socket-outlet before cleaning or maintaining the appliance.
28. Use only with <KL-WE180100-R / S018-1B180100HE> supply unit. This appliance contains batteries that are non-replaceable.
29. **WARNING:** For the purposes of recharging the battery, only use the detachable supply unit provided with this appliance.

# Recycling Instructions according to Battery Law



The rechargeable battery contains materials that are harmful to the environment and must therefore be removed from the device before disposal. The device must be switched off to remove the rechargeable battery.

Batteries and rechargeable batteries must not be disposed of in household waste! Every consumer is obliged to hand in all batteries and rechargeable batteries, regardless of whether they contain harmful substances or not, at a collection point in his or her municipality/district or at a retailer, so that they can be disposed of in an environmentally friendly manner. Batteries and rechargeable batteries should only be returned when discharged. Batteries and rechargeable batteries are therefore marked with the symbol left.

EN

# Recycling Instructions according to WEEE



Waste electrical and electronic equipment must not be disposed of with household waste! Every consumer is obliged to hand in all appliances at the end of their service life at a collection point in his or her municipality/district or at a retailer so that they can be disposed of properly and in an environmentally friendly manner.

The illustration left shows the wheelie bin symbol indicating separate collection of waste electrical and electronic equipment (WEEE).

## For EU Countries:

For EU Declaration of Conformity information, please visit [www.tineco.com](http://www.tineco.com).

## Symbols:

	Read the instruction manual
	Class II
	Short-circuit-proof safety isolating transformer
	Switch mode power supply
	For indoor use only
	Direct current
	Alternating current

# Specifications

Product	PURE ONE AIR PET SERIES
Voltage	14.4V $\equiv$
Rated Power	230W
Dustbin Capacity	0.3L
Charging Time	3-3.5 hrs
AC Input	100-240V $\sim$

# Overview

EN

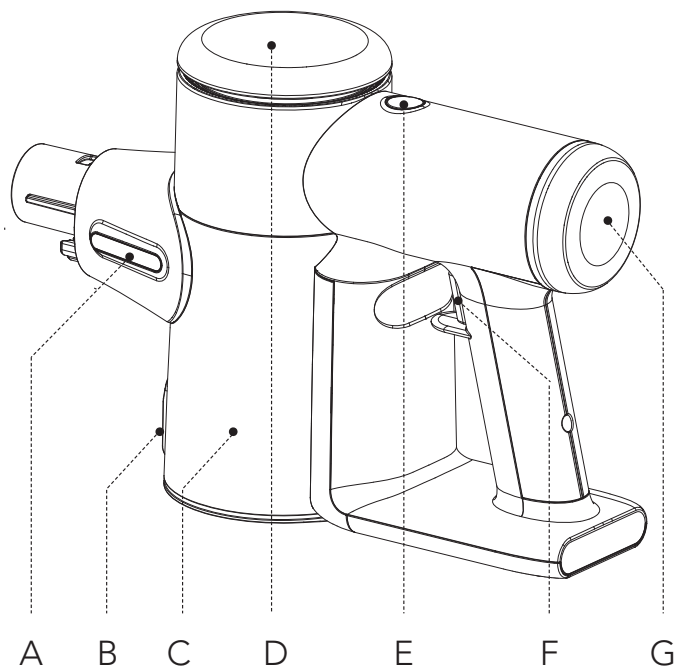

A. Dust Sensor

B. Dust Empty Release Button

C. Dustbin

D. HEPA Filter

E. Auto/Max Mode

F. Power Button

G. Digital Display

# Digital Display

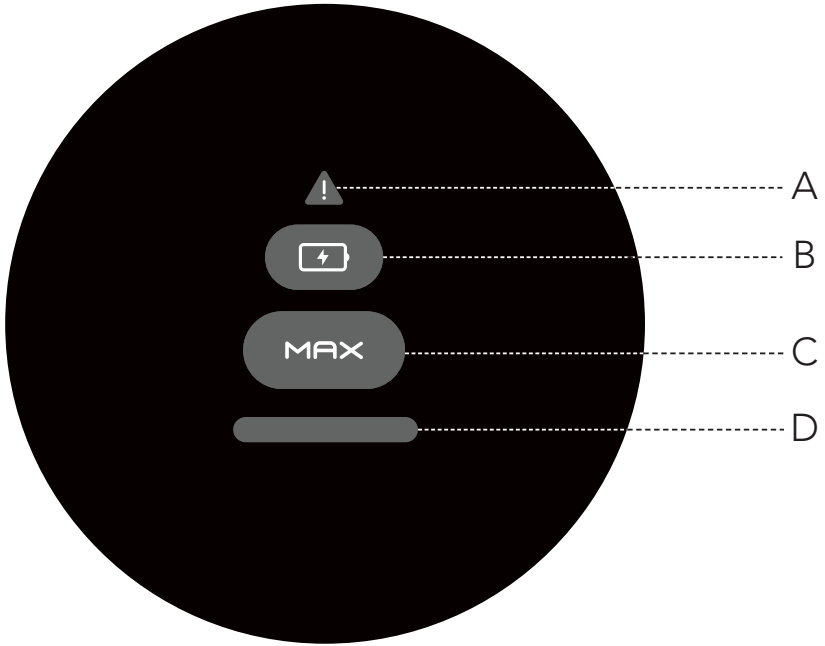

A. Malfunction  
B. Battery

C. MAX Mode  
D. Dust Monitoring Light

# Accessories

## Note:

- Test an accessory on a small, inconspicuous area before use on sensitive surfaces.
- To identify what should be included with your purchase, please refer to the packaging box.
- As shown below, there are many components compatible with this model. If you require more accessories, please go to [www.tineco.com](http://www.tineco.com) or [store.tineco.com](http://store.tineco.com).

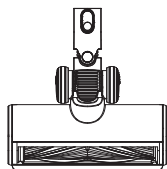

### Anti-tangle full-size power brush

Ideal for both hard floors and carpets. Picks up ground-in dirt with no hair wrap.

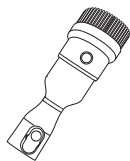

### 2-in-1 dusting brush

Switches between a wide and a soft brush by pressing the release button. The soft brush is most effective on hard-surface furniture while the wide brush is effective for upholstered furniture, curtains, etc.

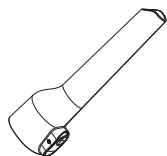

### Crevice tool

For corners, nooks, and other hard-to-reach places such as around car seats, picture frames, and cupboards.



### Hair cleaning tool

Use the end with the small blade to remove hair and debris wrapped around the roller.

Use the end with the brush to clean the brush window, and the dustbin, as required.

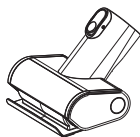

### Mini power brush

For vacuuming upholstered furniture, mattresses etc. Vacuums pet hair and removes ingrained dirt.



### Soft dusting brush

Angled bristles on a slender, oval-shaped rim provide anti-static, cushioned contact. Suitable for dusting shelves, lighting, delicate surfaces, electronics and more.

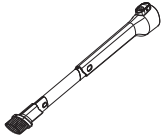

### Flexible long crevice tool

Easy to bend, easy to reach tight spots. Suitable for cleaning dust behind and beneath furniture, around refrigerators, and many other tight gaps.

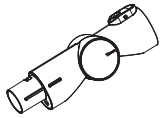

### Multi-angle folding tube

An articulated joint makes it adjustable to allow for flexibility when cleaning from high to low.

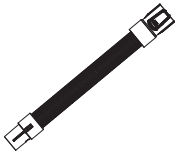

### Flexible extension hose

Excellent extension and flexibility to access hard-to-reach spaces; perfect for in-care use.  
Compatible with all non-motorized Tineco accessories.

# Assembly

## Tube Installation

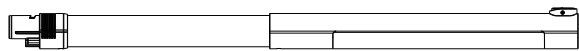

Insert tube.

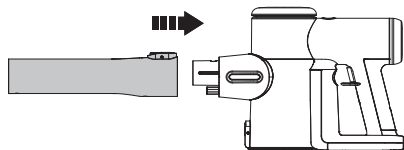

Insert to the main body.

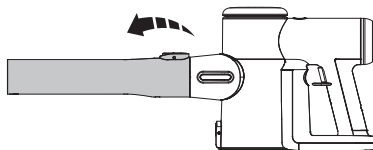

Press the release button to remove the tube.

## Brush Installation

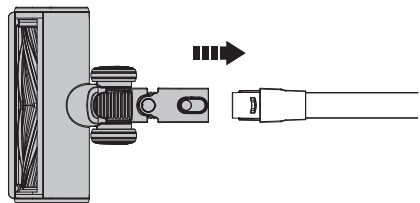

Insert the power brush.

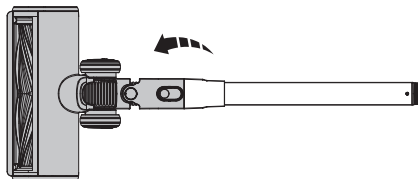

Press the release button to remove the power brush.

## Charging Dock Installation

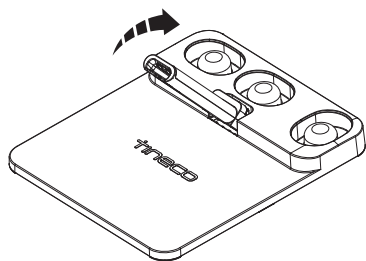

Lift up the charging post to the upright position.

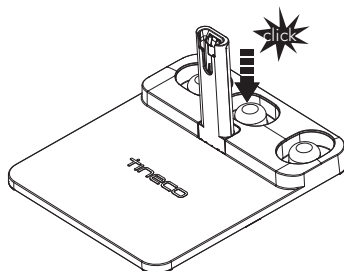

Press hard to fix the charging post firmly on the dock.

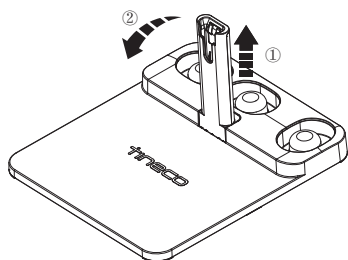

For easy storage, pull up the charging post and then press down.

# Operation

## Preparing for Use

### Note:

- Before the first use, please charge the appliance (see "Charging the Battery") for 3-3.5 hours in an area where the ambient temperature is between 39.2°F (4°C) and 104°F (40°C).
- Select an accessory and attach it to the appliance before use (see "Accessories").

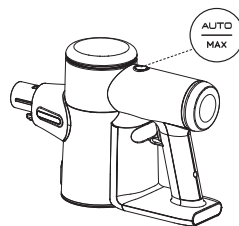
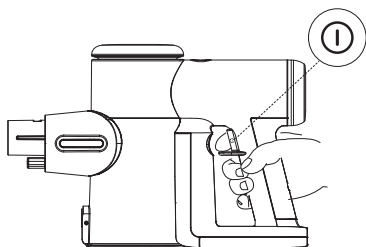

Press the  button to activate the suction.  
Press it again to turn off the appliance.

The appliance will start in AUTO mode by default. Press the  button to switch between AUTO and MAX mode.

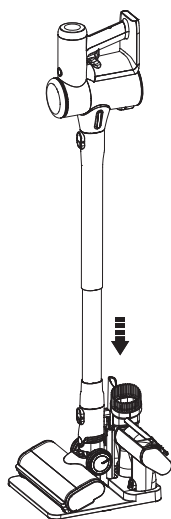

Place the appliance and attachments on the charging dock for convenient storage after use.

# Cleaning Mode Selection

## AUTO Mode

- In AUTO mode, the color of dust monitoring light change according to the amount of dust detected.
- The red dust monitoring light indicates more dust is detected whereas the blue light indicates less is detected. This mode automatically provides the best cleaning solution.

To enter AUTO mode:

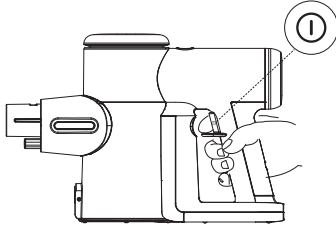

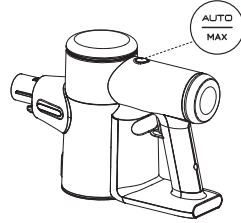

Press the power button to activate the suction. The default setting on startup is AUTO mode.

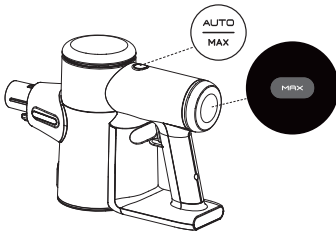

When in MAX mode, press the  button to enter AUTO mode.

## MAX Mode



In AUTO mode, press the  button to enter MAX mode.

### Note:

Keep sharp objects away from the digital display screen to avoid scratches and scrapes.

## Emptying the Dustbin

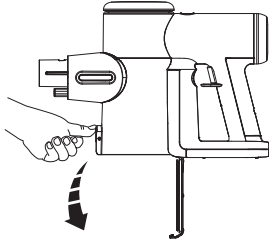

Press the release button on the side of the dustbin to empty the contents.

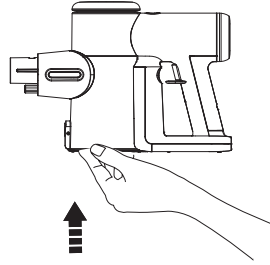

Close and click the dustbin flap back into place.

## Charging the Battery

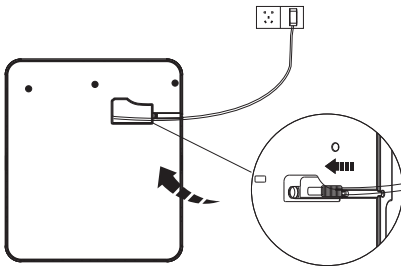

Plug the adaptor into the charging port at the bottom of the dock.

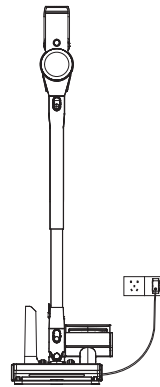

Place the appliance on the charging dock and plug the adaptor into a wall outlet.

### **Warning:**

- Only use the Tineco-provided adaptor to charge the appliance.
- To avoid trip hazards, please place the appliance securely on the charging dock, near a wall during charging.
- During long periods of not being used, store the appliance in a cool, dry place. Ensure the battery is fully charged every 3 months.
- Do not expose appliance to sunlight or freezing temperature. Recommended temperature range: 39.2°F (4°C)~104°F (40°C).

## Runtime

- When in AUTO mode, the runtime is approximately 30 minutes. When MAX power is used, the runtime is approximately 10 minutes.
- Estimated runtime data was obtained by a Tineco Laboratory using one battery and non-motorized accessories.

## Charging Time

- A full charge takes approximately 3-3.5 hours.
- Estimated data was obtained by a Tineco Laboratory using ambient temperatures between 39.2°F (4°C) to 104°F (40°C).

## Indicator

### When in Use



Solid red light: motor failure, check troubleshooting.



Blinking: air channel blocked / brush roller blocked, check troubleshooting.



Blinking: battery level < 5%.

### During Charging



Breathing green light: charging.

### Fully Charged



Battery level: 100%.

# Maintenance

## Note:

- Clean the dustbin and filters after each use.
- Wash and dry the HEPA filter every 3 months, replacing it every 12 months.

## Dustbin and Mesh Filter

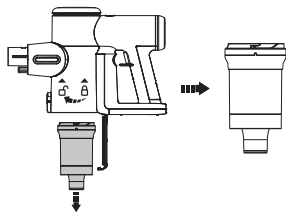

Turn counter-clockwise to remove the mesh filter.

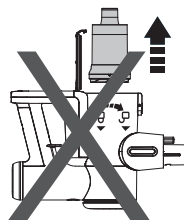

Do not turn the appliance upside down when removing or installing the mesh filter to prevent dust from entering the motor.

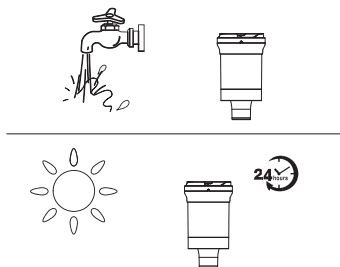

The mesh filter can be washed under cold running water and must be completely dry before reinstalling.

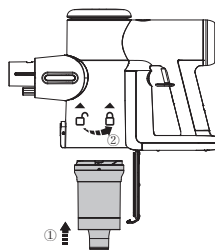

After cleaning, install the clean filter back into the main body, then close the dustbin flap.

## HEPA Filter

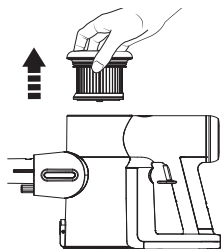

Pull out the HEPA filter (in magnetic design) for cleaning. Do not use the appliance without first installing the HEPA filter.

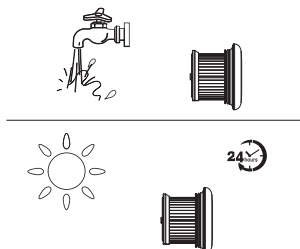

The HEPA filter can be washed under running water and must be completely dry before reinstalling.

## Dust Sensor

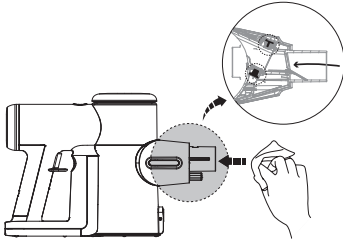

To avoid dust accumulation which can affect cleaning performance, wipe the suction mouth with a damp cloth.

## Brush Roller

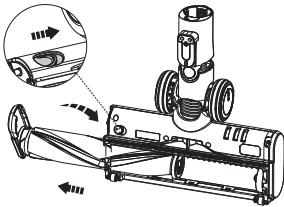

With the power off, slide the switch to open the brush roller end cover, and rotate it counter-clockwise to pull out the brush roller.

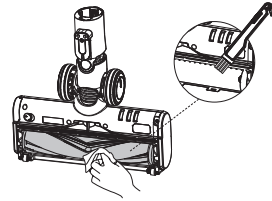

After removing the brush roller, gently clean the brush window, suction mouth and the row of plastic teeth.

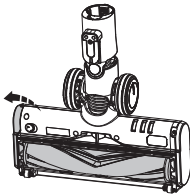

Fully reinsert the brush roller into the brush window and the end cover can be rotated counter-clockwise until it clicks securely back into place.

### **Warning:**

- The power brush contains electrical components which must not be soaked or washed with water.
- To reduce the injury, do not touch the brush roller while the appliance is in working condition.

# Troubleshooting

EN

Problem	Possible cause	Solution
The appliance does not turn on	No power	Charge the battery
	Auto protection for overheating	Restart after cooling down
	The appliance is blocked (i.e. the tube, suction mouth or some other parts)	Check and remove blockages
Weak suction power	Dustbin and filters are full	Clean the dustbin and filters
	The appliance is blocked (i.e. the tube, suction mouth or some other parts)	Remove blockages
	The brush roller tangled with hairs or fibers	Clean the brush roller
Battery won't charge	The adaptor is not correctly inserted	Reinsert the adaptor correctly
	The adaptor is not designed for this appliance	Use the original adaptor
Malfunction blinking	Air channel blocked	Remove blockages, clean the filter and dustbin
	The brush roller tangled with hairs or fibers	Clean the brush roller
	Motor failure	Restart after cooling down
	The sensor inside the dustbin is blocked	Clean the dust on the inner sensor
Abnormal motor sounds	The appliance is blocked (i.e. the tube, suction mouth or some other parts)	Remove blockages

**Note:**

If the above troubleshooting guide fails to provide a solution, please visit our website [www.tineco.com](http://www.tineco.com) for further support.

# Warranty

## 2-YEAR LIMITED WARRANTY

- Only applies to purchases made from authorized retailers of Tineco.
- Is subject to the adherence of the requirements outlined in this instruction manual, and is subject to further conditions outlined below.
- This warranty is governed by and construed under the laws of the country in which the purchase took place. We provide 2-year warranty or a warranty period as stipulated by applicable local law, whichever is longer.

## WHAT IS COVERED?

- Your Tineco appliance has a 2-year warranty against original defects in material and workmanship, when used for private household purposes in accordance with the Tineco Instruction Manual. Motorized accessories and battery bought separately come with a 1-year warranty.
- This warranty provides, at no extra cost to you, all labor and parts necessary to ensure your appliance is in proper operating condition during the warranty period.
- This warranty will only be valid if the appliance is used in the country in which it was sold.

## WHAT IS NOT COVERED?

Tineco shall not be liable for costs, damages or repairs incurred as a result of:

- Appliances purchased from an unauthorized dealer.
- Careless operation or handling, misuse, abuse and/or lack of maintenance or use not in accordance with the Tineco Instruction Manual.
- Use of the appliance other than for normal domestic purposes, e.g. for commercial or rental purposes.
- Use of parts not in accordance with the Tineco Instruction Manual.
- Use of parts and accessories other than those produced or recommended by Tineco.
- External factors unrelated to product quality and use, such as weather, modifications, accidents, electrical outages, power surges or acts of God.
- Repairs or alterations carried out by unauthorized parties or agents.
- Failing to clear blockage and other hazardous material from the appliance.
- Normal wear and tear, including normal wearing parts, such as clear bin, belt, filter, HEPA, brush bar, and power cord (or where external damage or abuse is diagnosed), carpet or floor damage due to use not in accordance with manufacturer's instructions or failure to turn the brush bar off when necessary.
- Reduction in battery discharge time due to battery age or use.

## WARRANTY LIMITATIONS

- Any implied warranties relating to your appliance including but not limited to warranty of merchantability or warranty of fitness for a particular purpose, are limited to the duration of this warranty.
- Warranty coverage applies to the original owner and to the original battery only and is not transferable.
- This limited warranty gives you specific legal rights. You may also have other rights which vary by region.
- Manufacturer's warranties may not apply in all cases, depending on factors such as use of the product, where the product was purchased, or who you purchased the product from. Please review the warranty carefully, and contact the manufacturer if you have any questions.

## WARRANTY SERVICE

**Register:** We highly recommend that upon purchase, you register your appliance on the Tineco official website ([www.tineco.com](http://www.tineco.com)) and enjoy exclusive benefits. To register, please enter the whole serial number (found on the base of the main body).

Failure to register your product won't diminish your warranty rights.

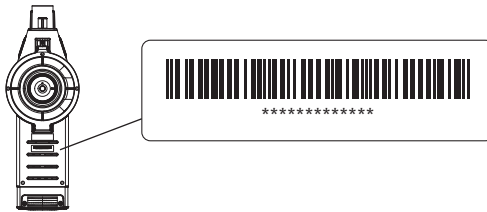

**How to Claim:** Please retain your proof of purchase. To make a claim under our Limited Warranty, you need to provide your serial number and the original purchase receipt with the purchase date and order number on it.

All work will be carried out by Tineco or an authorized agent.

Any replaced defective parts will become the property of Tineco.

Service under this warranty will not extend the period of this warranty.

Contact our Customer Service  
Hotline: **0808-1969-728**  
or Visit Tineco website  
**[www.tineco.com](http://www.tineco.com)**  
for expert customer service.



**tineco**

Live Easy.  
Enjoy Life.

Didistribusikan dan Diimport :  
PT. MAZUTA BIMA TEK  
SURABAYA - JAWA TIMUR - INDONESIA

Jl. Pattimura (Ruko Plaza Segi Delapan Kav.A-836),  
Desa/Kelurahan Sonokwijen, Kec. Sukomanunggal,  
Kota Surabaya, Provinsi Jawa Timur,  
Kode Pos: 60189

IMKG.3439.12.2024

**Customer Care :**  
0811 3225 6666

tineco

Diimpor dan didistribusikan oleh:  
**PT. MAZUTA BIMA TEK**  
Surabaya - Jawa Timur - Indonesia

## Kartu Garansi

### PURE ONE AIR PET / VS161100ID

Service Center :

Tangerang  
Duta Indah Iconic Unit B5-B6  
Jalan MH. Thamrin KM.2,  
Panunggangan Utara, Kec. Pinang,  
Kota Tangerang, Banten 15143

Nama : \_\_\_\_\_

Alamat : \_\_\_\_\_

Surabaya  
KomplekPlaza Ruko Segi 8 blok A836,  
Jalan Pattimura, Sonokwijenan  
Kec. Sukomanunggal, Surabaya 60189

No. Telp : \_\_\_\_\_

☎ 1500 699 📞 0811 3225 6666

**Kartu Garansi resmi berlaku 24 bulan  
setelah pembelian.**

IMKG.3439.12.2024

**TINECO INDONESIA**

#### **GARANSI TERBATAS SELAMA 2-TAHUN**

- Hanya berlaku untuk pembelian yang dilakukan dari **CV Wisnu Tek Indonesia**.
- Kondisi alat sesuai dengan ketentuan yang berlaku pada buku panduan dan ketentuan yang lebih lanjut dibawah ini.

#### **APA SAJA YANG TERCAKUP?**

- Produk Tineco anda memiliki garansi 2 tahun terhadap kerusakan yang disebabkan oleh kecacatan dalam pembuatan material, dan digunakan untuk keperluan rumah tangga pribadi sesuai dengan buku panduan Tineco. Baterai & segala jenis motor garansi 1 tahun.
- Garansi ini diberikan tanpa ada biaya tambahan kepada anda, seluruh pengerjaan service dan suku cadang yang diperlukan agar memastikan kondisi produk dalam keadaan baik selama masa garansi.
- Garansi ini hanya akan berlaku jika produk digunakan di negara tempat produk tersebut dijual.

#### **APA SAJA YANG TIDAK TERCAKUP?**

- Tineco tidak bertanggung jawab atas biaya kerusakan atau perbaikan produk yang terjadi sebagai akibat dari:
- Pembelian produk bukan dari penjual resmi.
  - Penggunaan atau penanganan yang ceroboh, penyalahgunaan dan/atau kurangnya perawatan atau penggunaan yang tidak sesuai dengan instruksi pada buku panduan.
  - Menggunakan produk selain untuk keperluan rumah tangga, mis. untuk tujuan komersial atau persewaan.
  - Penggunaan suku cadang yang tidak sesuai dengan instruksi pada buku panduan Tineco.

- Penggunaan suku cadang dan aksesoris selain yang diproduksi atau direkomendasikan oleh Tineco.
- Faktor eksternal yang tidak terkait dengan kualitas penggunaan produk, seperti cuaca, modifikasi produk, kecelakaan, pemadaman listrik atau bencana alam lainnya.
- Perbaikan atau modifikasi produk yang dilakukan oleh pihak atau agen yang tidak berwenang.
- Salah membersihkan benda yang menyumbat dan bahan yang berbahaya dari produk.
- Keausan normal seperti dustbin, belt, filter, HEPA, bar brush dan kabel listrik (atau didiagnosis adanya penyalahgunaan eksternal yang menyebabkan bahaya), dan lantai yang rusak, penggunaan tidak sesuai dengan petunjuk pabrik, dan kegagalan untuk mematikan bar brush saat di perlukan.
- Berkurangnya daya baterai yang disebabkan oleh masa pemakaian baterai.

Tempelkan nota pembelian anda disini

**Tangerang**

Komplek Duta Indah Iconic Unit B5-B6. Jl. MH. Thamrin Km.02 Kec. Pinang, Kota Tangerang, Banten 15143

**Jakarta**

ITC Cempaka Mas Lt. 6 Pusat Komputer Blok H 09-12, Jl. Letjen Suprpto No.629-632, RW.8, Sumur Batu, Kec. Kemayoran, Daerah Khusus Ibukota Jakarta 10640

**Surabaya**

Komplek Plaza Ruko Segi 8 Blok A-836, Jalan Pattimura, Sonokwijenan, Kec. Sukomanunggal, Surabaya, Jawa Timur 60189

**Jakarta**

Unicom ITC Roxy Mas, Jl. Kh Hasyim Ashari, ITC Roxy Mas Lt. 2 No. 82 - 84, Cideng, Gambir, Jakarta Pusat, DKI Jakarta 10150

**Jakarta**

Duta Merlin Komplek Perkantoran Duta Merlin Blok C, No. 6-7, Jl. Gajah Mada No. 3-5, Petojo Utara, Gambir, Jakarta Pusat, DKI Jakarta 10130

**Tangerang**

Lippo Karawaci, Area E Center Lt. LG B6/1, Jl. Boulevard Diponegoro No.108, Bencong, Kec. Klp. Dua, Kabupaten Tangerang, Banten 15810

**Surabaya**

Surabaya Jl. Mayjen Prof. Dr. Mustopo No. 69-B Kel Pacar Kembang, Tambaksari, Surabaya, Jawa Timur

**Surabaya**

WTC LT.II, Jl. Pemuda, Embong Kaliasin, Kec. Genteng, Surabaya, Jawa Timur 60623

**Bandung**

Bandung Komplek Ruko Hyper Square No. A2 Bandung, Jl. Pasir Kaliki, Kota Bandung, Jawa Barat 40172

**Bekasi**

Bekasi Hypermall, Jl. Ahmad Yani No.35 Lantai 1 Blok H, RT.004/RW.001, Marga Jaya, Kec. Bekasi Sel., Kota Bks, Jawa Barat 17144

**Bandung**

Gedung BEC 2 Lt. UG Y07-08, Jl. Purnawarman No.1, Babakanciamis, Sumurbandung, Bandung City, West Java 40117

**Depok**

Depok Town Square, Jl. Margonda No.02, Kemiri Muka, Kecamatan Beji, Kota Depok, Jawa Barat 16424

**Bogor**

Unicom Care Bogor Bogor Trade Mall Lt 2 Blok 2F A10, Jl. Ir. H. Juanda No.009A, RT.01/RW.13, Paledang, Kecamatan Bogor Tengah, Kota Bogor, Jawa Barat 16127

**Semarang**

Jl. Tentara Pelajar No. 3, Jomblang, Candisari Semarang, Jawa Tengah 50256

**Medan**

Medan Ruko Royal Residence, Jl. Suka Mulia No. 3, Kota Medan

**Pontianak**

Jl. Slt. Abdurrahman No.38A Lantai 2, Akcaya, Kec. Pontianak Sel., Kota Pontianak, Kalimantan Barat 78113

**Pekanbaru**

Jl. Jend. Sudirman Mal No.8 Lt.2 Blok E2, Kota Tinggi, Kec. Pekanbaru Kota, Kota Pekanbaru, Riau 28155

**Purwokerto**

Jl. Prof. Dr. Suharso, Arcawinangun, Bancarkembar, Purwokerto Utara, Banyumas Regency, Central Java 53114

**Solo**

Honggowongso Square A3, Jl. Honggowongso No.83 Lt. 2, Kemlayan, Serengan, Surakarta City, Central Java 57149

**Bandar Lampung**

Jl. Diponegoro No.86F, Gulak Galik, Kec. Tik. Betung Utara, Kota Bandar Lampung, Lampung 35212

**Kediri**

Jl. Dhoho No.192, Pakelan, Kec. Kota,Kota Kediri, Jawa Timur 64126

**Malang**

Mall Olympic Garden (MOG), Lt. 2 Blok. SF-81. Jl. Kawi No.24,  
Kauman, Kec. Klojen, Malang, Jawa Timur - 65116

**Jember**

Unicom Care at Grand Cellular (Area Parkir Belakang), Jl. Jawa No.28A,  
Tegal Boto Lor, Sumbersari, Jember Regency, East Java 68121

**Yogyakarta**

Jl. Letjen Suprpto No.26, Ngampilan, Kota Yogyakarta,  
Daerah Istimewa Yogyakarta 55261

**Pekalongan**

Unicom Care at Sholeh Store, Jl. Urip Sumoharjo, Podosugih,  
Pekalongan Barat, Pekalongan City, Central Java 51111

**Balikpapan**

Ruko KM. 4 No. 4, Andalas II 2 Jl. Soekarno Hatta,  
Batu Ampar, Balikpapan, Kalimantan Timur 76125

**Tegal**

Jl. Arjuna No.24, Slerok, Kec. Tegal Tim., Kota Tegal, Jawa Tengah 52125

**Pati**

Jl. Kamandowo, Pati Kidul, Kec. Pati, Kabupaten Pati, Jawa Tengah 59114

**Cirebon**

Jl. Petratean No.11b, Pekalipan, Kec. Pekalipan, Kota Cirebon, Jawa Barat 45117

**Bali**

Jl. Teuku Umar No. 77, Dauh Puri Kauh,  
Kec. Denpasar Barat, Kota Denpasar, Bali 80113

**Banjarmasin**

Jl. Veteran No.7, Kuripan, Kec. Banjarmasin Tim.,  
Kota Banjarmasin, Kalimantan Selatan 70238

**Samarinda**

Unicom Care Samarinda, Jl. Aminah Syukur No.2a, Sungai Pinang Luar,  
Kec. Samarinda Kota, Kota Samarinda, Kalimantan Timur 75242

**Makassar**

Ruko Latanete, Jl. Sungai Saddang Lama No.4 Blok D, Pisang Sel.,  
Kec. Ujung Pandang, Kota Makassar, Sulawesi Selatan 90114

**Medan**

Ruko Plaza Millenium Medan, Jl. Kapten Muslim No.19A, Dwi Kora,  
Kec. Medan Helvetia, Kota Medan, Sumatera Utara 20123

**Purwokerto**

Jl. Prof. Dr. Suharso, Arcawinangun, Bancarkembar, Purwokerto Utara,  
Banyumas Regency, Central Java 53114

**Makassar**

Jl. Rappocini Raya No.41, Rappocini, Kec. Rappocini, Kota Makassar,  
Sulawesi Selatan 90222

**Palembang**

Unicom Care at Sriwijaya Selular Lt. 2, Palembang Square, Jl. Angkatan 45 No.68 Blok R  
Lorok Pakjo, Kec. Ilir Bar. I, Kota Palembang, Sumatera Selatan 30137

**Palembang**

Jl, Jl. Dr. M. Isa No.1172 B, RT.015/RW.04, Kuto Batu, Kecamatan Ilir Timur Tiga,  
Palembang City, South Sumatra 30163